

## UNIGRID SİSTEM

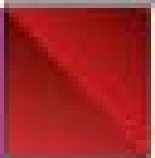

**butem**  
metal form sanayi ve ticaret a.ş.

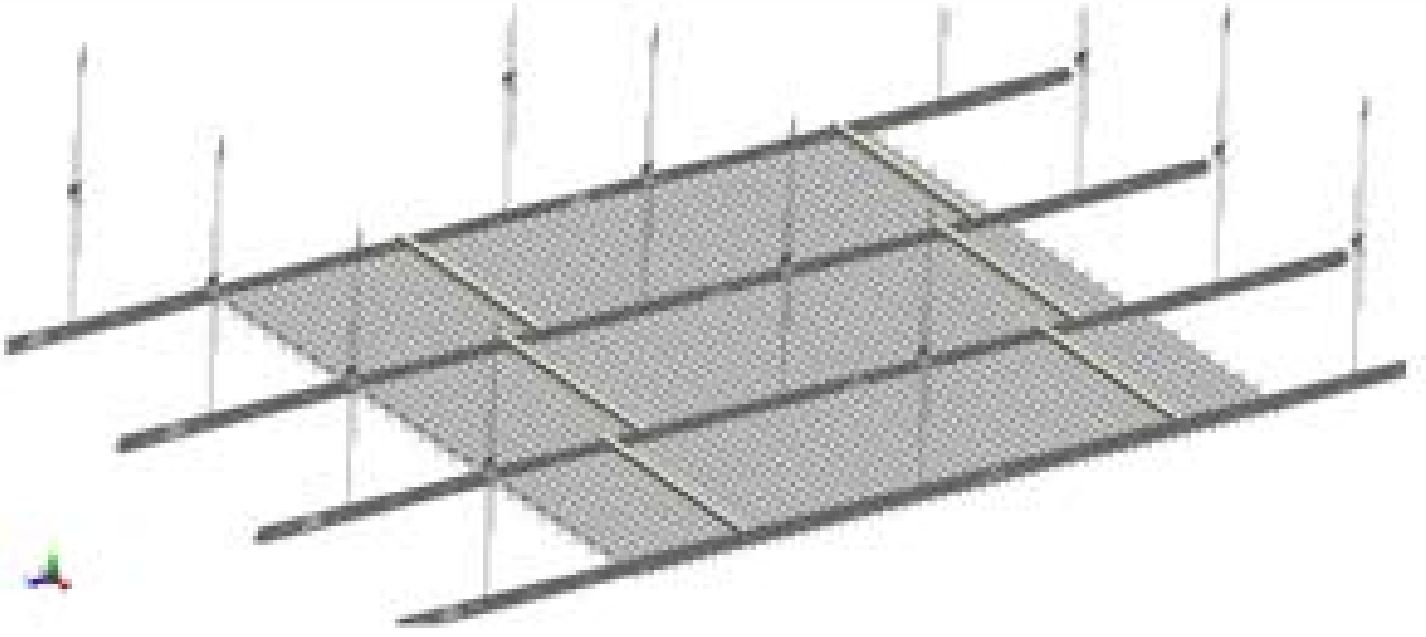

Unigrig sistemi, T-24 kesitli taşıyıcılarla uygulanan metal asma tavan sistemleridir. Profiller tavan yüzeyinde görünmez.

Paneller, sökme aparatı kullanılmasına gerek kalmadan kolayca sökülebilir. Hücresel yapısından dolayı tavan arkası hacminde hava sirkülasyonunda kullanımına izin verir. Farklı tip aydınlatma uygulamalarına seçenek sağlar.

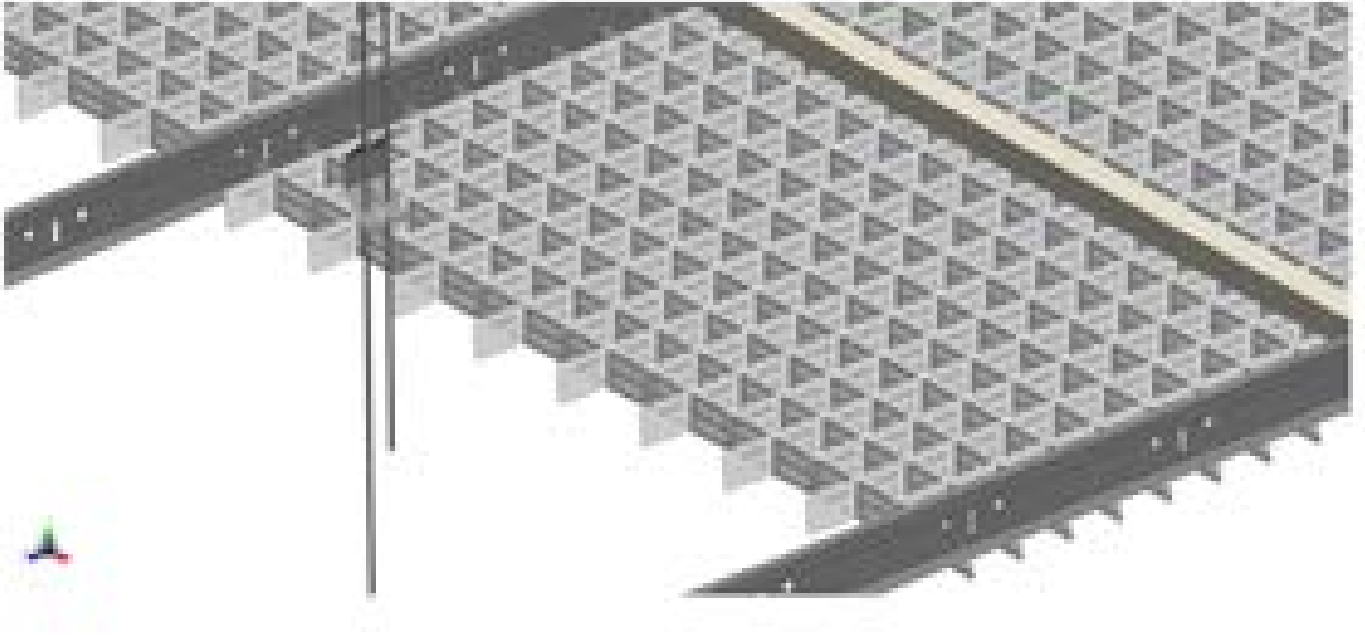

# Unigridd Sistem

## Perspektif

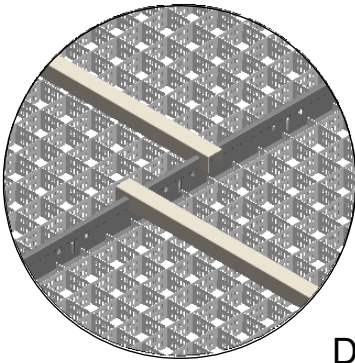
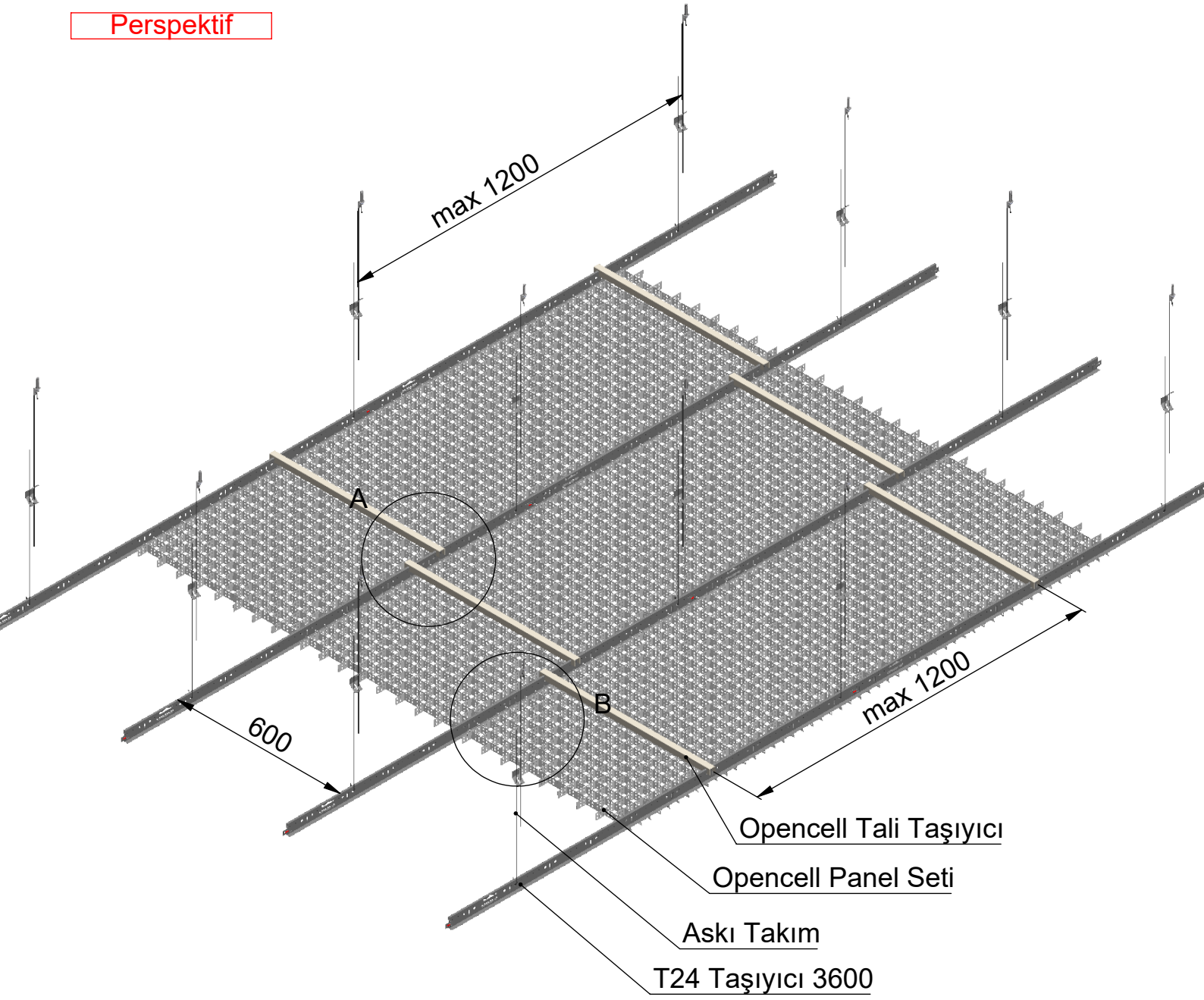

Detay A

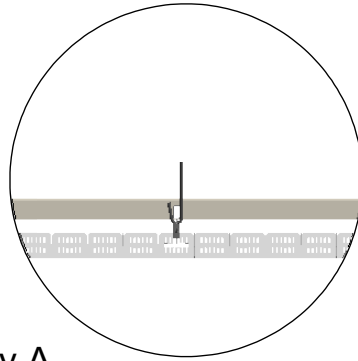

Detay B

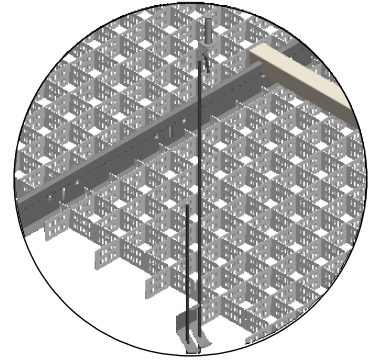

Panel Detayı

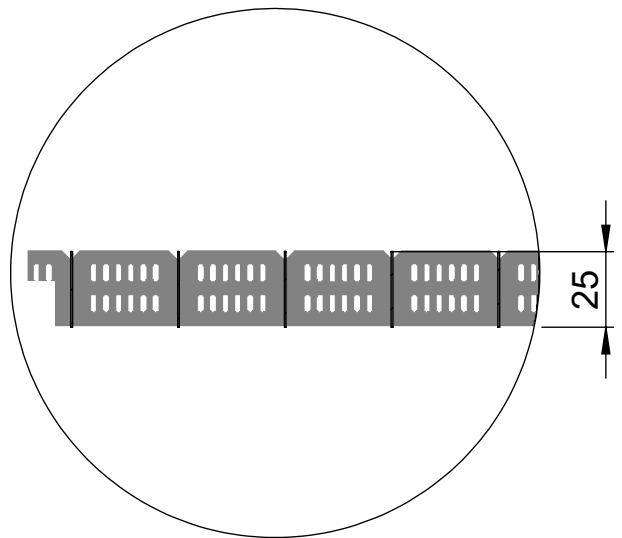
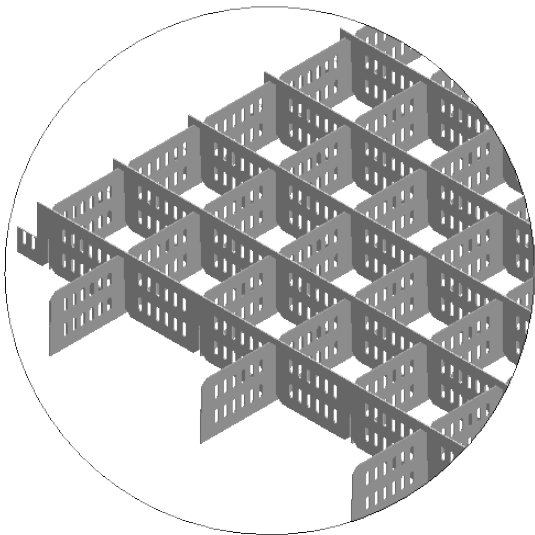
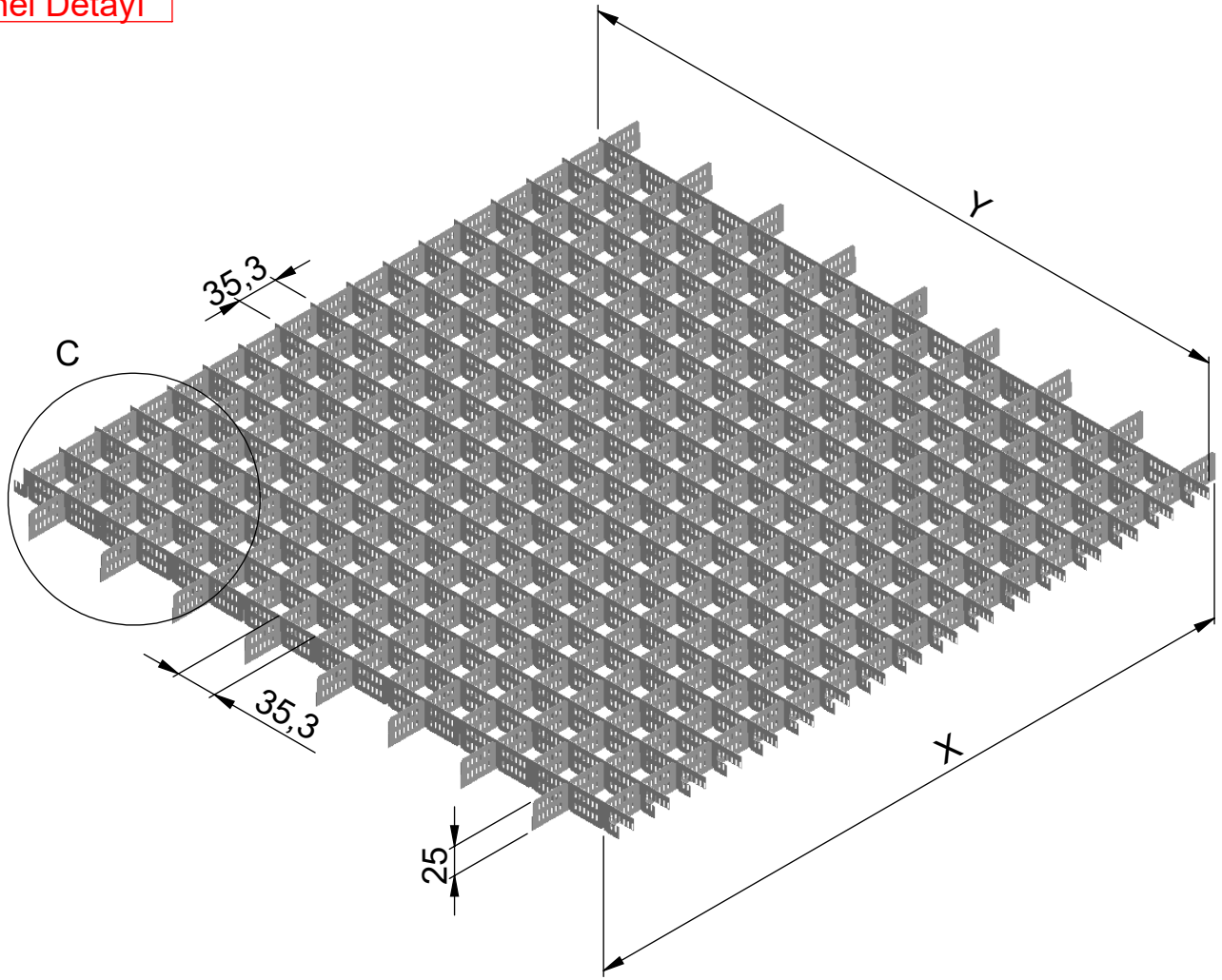

Detay C

# Declaration of Performance



No:A-INT.PD20171001-01

<b>1.Uniquade identification code of the product-type:</b>	<b>"BUTEM"</b> Metal Ceiling Systems
<b>2.Type, batch or serial number or any other element allowing identification of the construction product as required pursuant to Article 11 (4):</b>	Product Type, Order/Batch Nr.
<b>3.Intended use or uses of the construction product, in accordance with the applicable harmonized technical specification, as foreseen by the manufacturer:</b>	Internally, to produce an installed suspended ceiling
<b>4.Name, registered trade name or registered trade mark and contact address of the manufacturer as required pursuant to Article 11 (5):</b>	<b>BÜTEM METAL FORM SANAYİ TİCARET A.Ş.</b> Osman Gazi Mahallesi Ziya Gökalp Caddesi No:10 Esenyurt Istanbul Turkey T:+90 (212)886 33 00 F:+90 (212) 886 33 10 www.butemmetal.com
<b>5.Where applicable, name and contact address of the authorized representative whose mandate covers the tasks specified in Article 12 (2):</b>	Not Applicable
<b>6.System or systems of assessment and verification of constancy of performance of the construction product as set out in Annex V:</b>	Systems 3
<b>7.In case of the declaration of performance concerning a construction product covered by a harmonized standard:</b>	(a)The manufacturer carrying out factory production control; (b) Turkish Standards Institution (TSE) /Notified Body No:1783 issued the Reaction to Fire classification report (Report No:TSE-19.01.2017-170050) according to TS EN 13501-1+A1:2013-04 as the notified testing laboratory (based on sampling carried out by the manufacturer).
<b>8.In case of the declaration of performance concerning a construction product for which a European Technical Assessment has been issued:</b>	Not Applicable

# Declaration of Performance



No:A-INT.PD20171001-01

## 9.Declared Performance

- (a) Column 1 shall contain the list of essential characteristics as determined in the harmonized technical specifications for the intended use or uses indicated in point 3 above.
- (b) For each essential characteristic listed in column 1 and in compliance with the requirements of Article 6, Column 2 shall contain the declared performance, expressed by level or class, or in a description, related to the corresponding essential characteristics. The letters 'NPD' (No Performance Determined) shall be indicated where no performance is declared.
- (c) For each essential characteristic listed in column 1, column 3 shall contain:
- I-Dated reference of the corresponding harmonized standard and, where relevant, the reference number of the Specific or Appropriate Technical Documentation used; or
  - II-Dated reference of the corresponding European Assessment Document where available and reference number of the European Technical Assessment used.

Essential Characteristics	Performance	Harmonized Technical Specification
<b>Reaction To fire</b>	A2-s1, d0	TS EN 13964:2014-04 + TS EN13501-1+A1:2010
<b>Release of Dangerous Substances</b>	No Content	TS EN 13964:2014-04 + TS EN13501-1+A1:2010
<b>Flexural Tensile Strength</b>	NPD	TS EN 13964:2014-04 + TS EN13501-1+A1:2010
<b>Thermal Conductivity</b>	NPD	TS EN 13964:2014-04 + TS EN13501-1+A1:2010
<b>Durability</b>	Corrosion Class B	TS EN 13964:2014-04 + TS EN13501-1+A1:2010
<b>Sound Absorption Single Value <math>a_w</math></b>	See Table Below	TS EN 13964:2014-04 + TS EN13501-1+A1:2010

Sound Absorption Single Value $a_w$	Perforation Types		
	Ø1,5 mm	Ø1,8 mm	Ø2,5 mm
JM 60	-	0,35	0,35
Royalin R6/60	0,60		
JM 60 Double	0,45		
JM60 with 25 mm 50 kg/m <sup>3</sup> rockwool	1,00		

- 10.The performance of the product identified in point 1 and 2 is in conformity with he declared performance in point 9.  
 This declaration of performance is issued under the sole responsibility of the manufacturer identified in point 4.